

**elevator
touchscreen
systems**

2020 product catalog



FIREFIGHTERS' OPERATION
SYSTÈME DE SECOURS SPÉCIAL



ELEVATOR
7

G





CALL RECEIVED - WHEN FLASHING
APPEL REÇU

Vous écoutez Musique Radio-Canada



PUSH FOR HELP
SECOURS

MAINTENANCE SERVICE
 514-393-2222
 1-877-393-2222
 1-877-393-2222

CALVANCE INC. (R)
 7

INSTALLATION #
 65488

ELEVATOR LINE NO. IS
 LOCATED IN MACHINE ROOM
 LE PERMIER EST SITUÉ DANS
 LA SALLE DE LA M.C.



PUSH FOR HELP
SECOURS

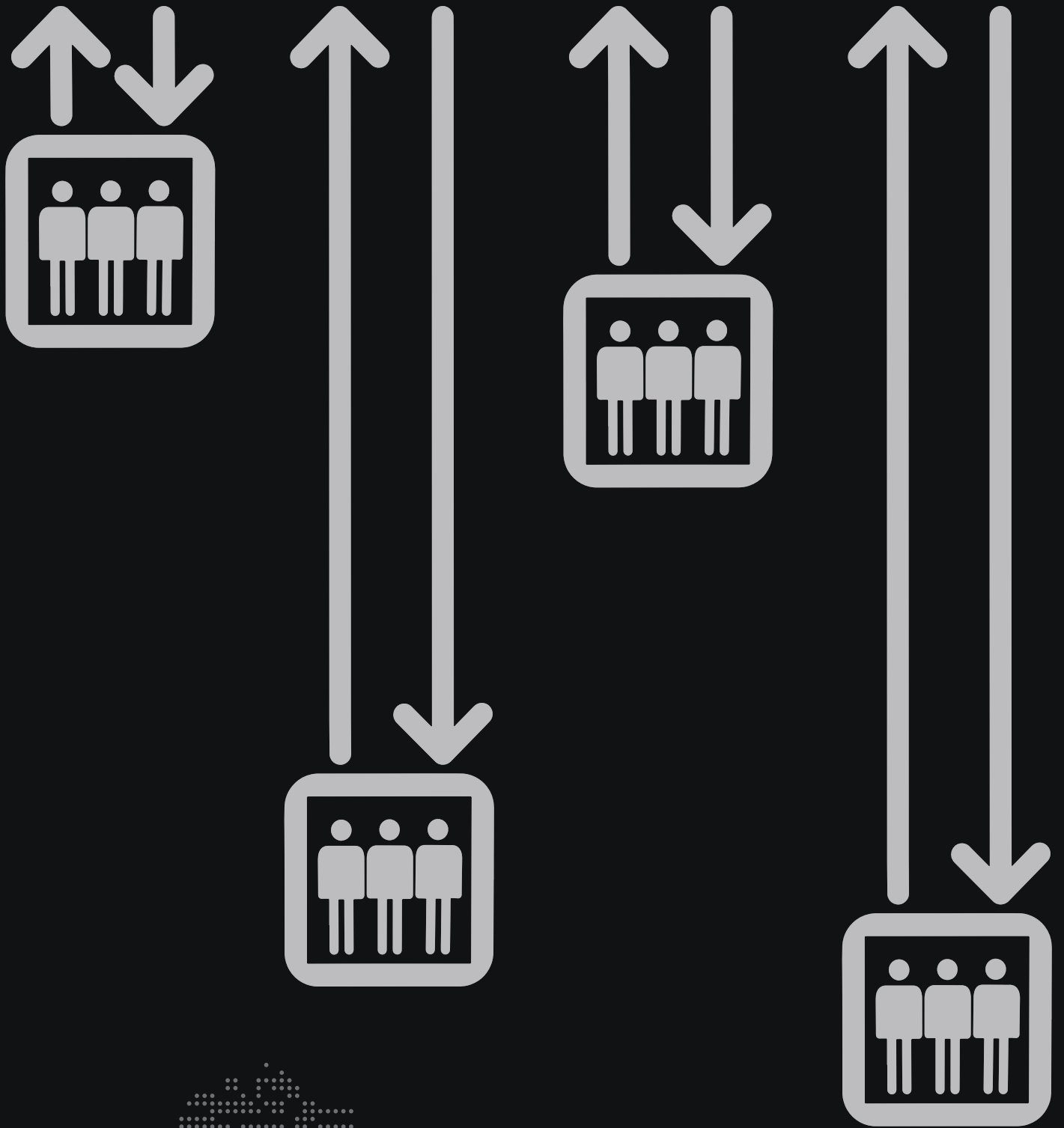

Founded in 2005, Touch-To-Go Technologies is the leader in elevator touchscreen systems. Our products have been sold to projects located throughout North America and internationally.



ELEVATOR TOUCHSCREEN SYSTEMS 2020 PRODUCT CATALOG

CONTENTS {

06	Overview
08	Graphics
24	Managing Content
26	Component Layout
31	Code Compliance
36	Specifications
37	Approvals

OVERVIEW

Elevators are one of the most frequently used common areas of a building. For 15 years, the Touch-To-Go elevator touchscreen system has improved the passenger experience.

The Touch-To-Go (TTG) elevator touchscreen system takes the place of conventional pushbuttons and transforms user-elevator interaction into a dynamic, visual experience. The touchscreen graphics interactively change upon touch-request.

The TTG system connects the same way as conventional pushbuttons, allowing maximum flexibility for fixture upgrades, full modernizations or new construction. It is compatible with any elevator controller.



Brand your elevator with logos, graphics & videos



Display advertisements and promote on-site events, restaurants or amenities



Change screen themes for holidays & occasions



Code Blue, Fire Service, and other emergency services available



Easy-to-clean surface with any glass-approved solution



Operated by finger-touch and with a gloved or covered hand

TOUCHSCREEN

ADA / Appendix E / Barrier Free compliance is achieved through either a keypad or redundant pushbuttons.

Emergency controls, door open, door close, etc. are still implemented with conventional pushbuttons; the touchscreen only supports selection of the destination floor.

The TTG system is made with a color LCD screen with an integrated touch-sensitive glass panel and a watertight bezel.

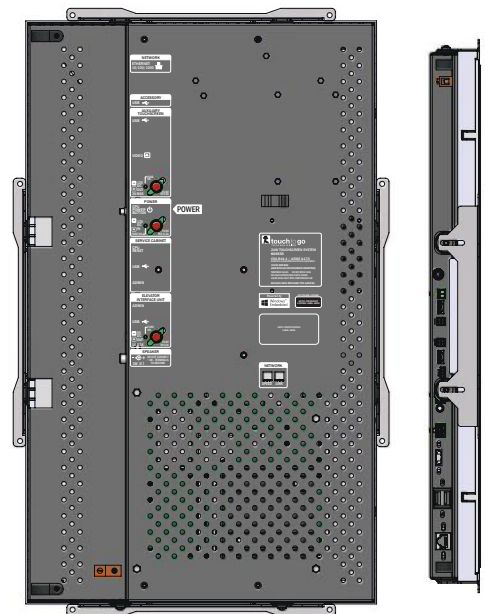

SPECIFICATIONS

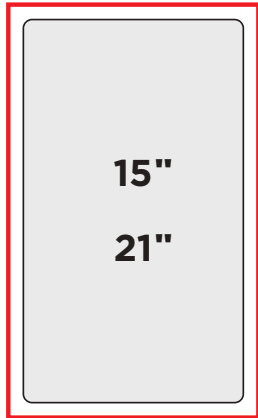

	15"	21"
Viewable Area	7.62"w x 13.55"h	10.6"w x 18.8"h
Overall Dimensions (with Mounting Bracket)	9.88"w x 15.75"h x 1.7"d	13"w x 21.05"h x 2.21"d
Resolution (px)	1080w x 1920h (Full HD)	1080w x 1920h (Full HD)
Glass Type	Tempered 6mm flush-mount glass	Tempered 3mm
Viewing Angle	Extra Wide (178°) LED	Extra Wide (178°) LED

17S, 19W, 19S and other sizes available upon special order.

TYPICAL INSTALLATION

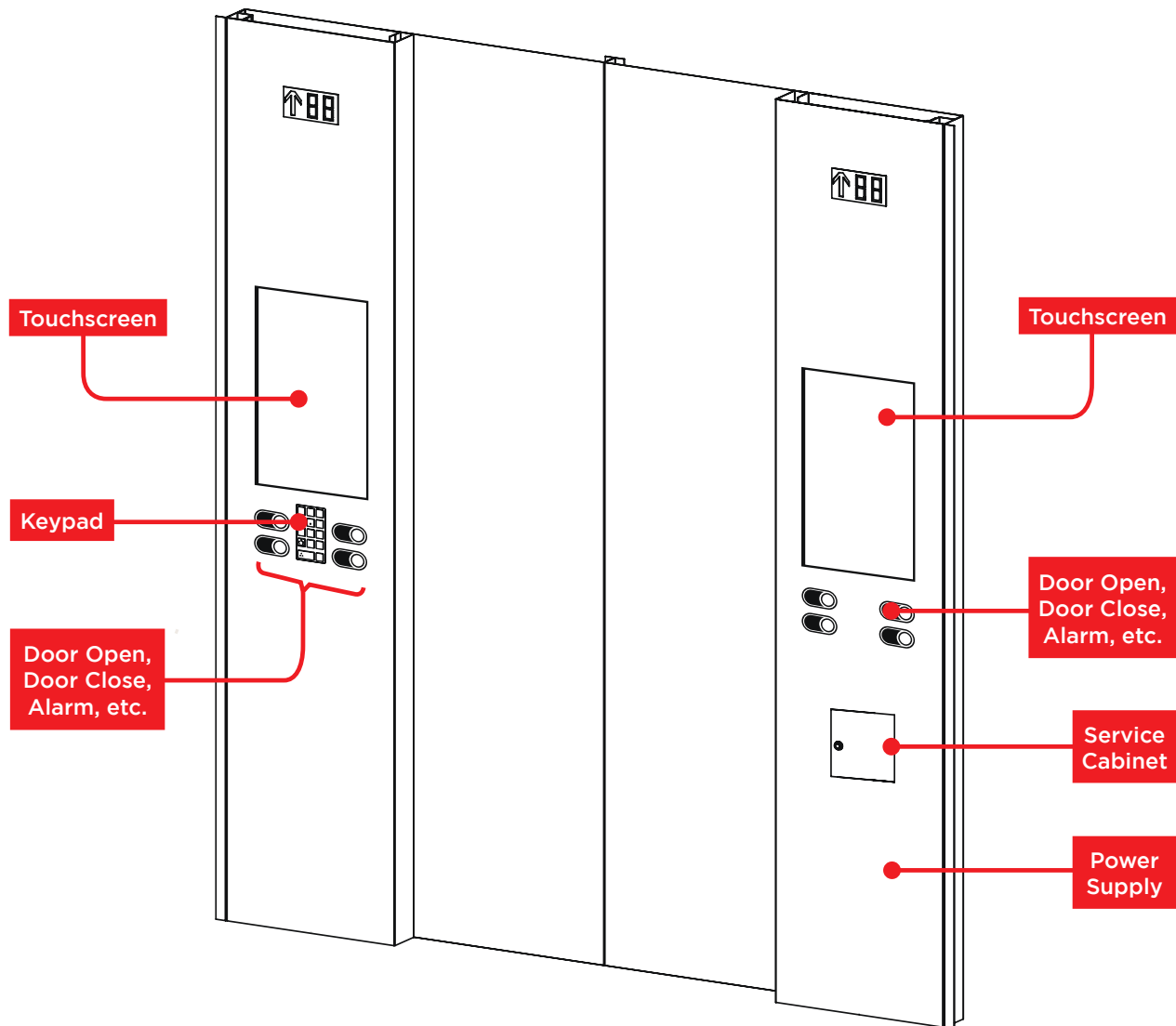

Typical installation in an elevator with center opening doors and dual swing-return COPs shown above.

RESIDENTIAL

Custom graphics and themes are created specifically for each project, showcasing the building's branding and style while helping passengers reach their destination.

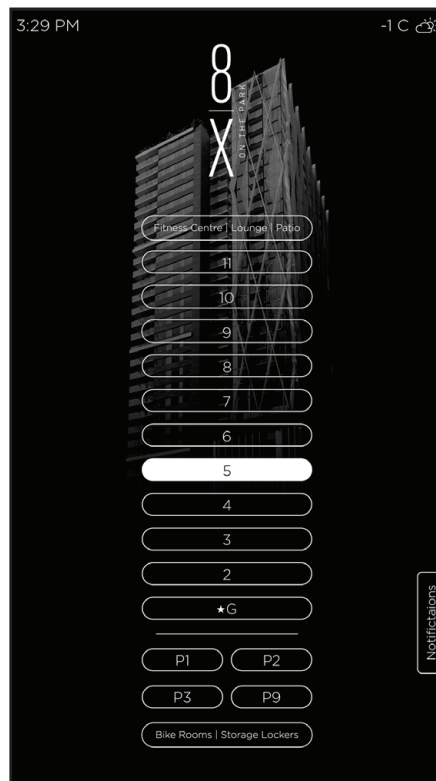
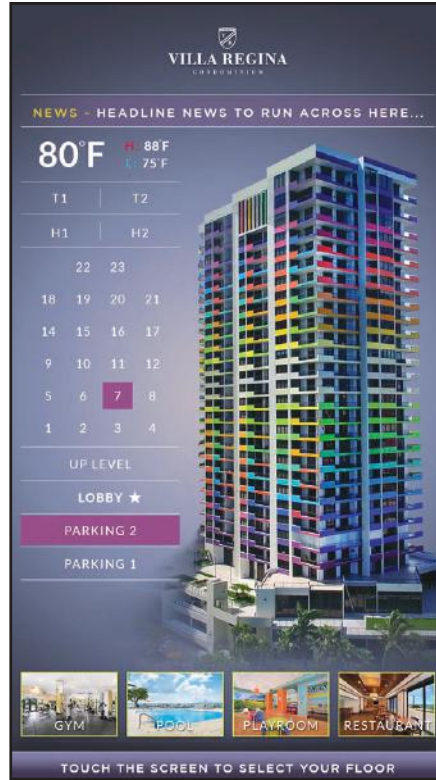
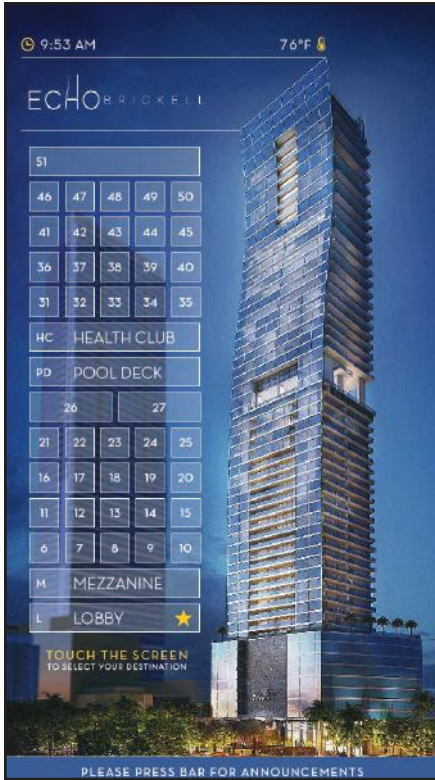

GRAPHICS

KEY FEATURES

- Architectural renderings can be incorporated into theme graphics to help visualize the floor destination, while reinforcing status associated with higher floors.
- On-site amenities can be promoted from within the elevator such as pool or gym.
- Screens provide relevant information to tenants such as time, weather, announcements, or building events (User-defined Areas). Update and schedule from anywhere with an Internet connection.
- Two-way video system allows for passengers to communicate with Concierge/Security via video call in the event of an emergency. Recommended for buildings with hearing or speech impaired residents (additional feature).
- Advanced attendant service gives remote elevator control to the Concierge/Security desk. After the visitor is authorized and in the elevator, the Concierge/Security can dispatch the elevator to the desired floors (additional feature).

User-defined Areas

THE ROY

PENTHOUSE

21 LOWER PENTHOUSE

17 18 19 20

13 14 15 16

9 10 **11** 12

ROY CLUB

P1 P2 P3 P4

★ LOBBY

BASEMENT SHIPPING

PRESS FOR ANNOUNCEMENTS

🕒 10:25 🌡️ 25°

Construction of world's tallest statue begins in India
Indian farmers were urged Thursday to hand over scraps of metal and tools for the world's tallest statue, as construction began on what promoters hope will be a wonder of the world.

PRESS FOR AMENITIES LEVEL

POOL / DINING ROOM / SAUNA / LOUNGE / FITNESS / THEATER / MEETING ROOM

ANNOUNCEMENTS

TOUCH THE SCREEN TO SELECT YOUR DESTINATION

IIIUSE

🌙 **84°F**
87F | 72F

43 44 45 LPH UPH

38 39 40 41 42

33 34 **35** 36 37

28 29 30 31 32

23 24 25 26 27

18 19 20 21 22

12 14 15 **16** 17

7 8 9 10 11

2 3 4 5 6

★ LOBBY ★

VANISHING-EDGE POOL FITNESS CENTER SPA

HOSPITAL

Colorful, high-contrast graphics and large touch areas make the screen easy-to-read and use in a variety of facilities, including in multi-lingual facilities.

4:32 PM Vancouver Coastal Health

TOUCH THE SCREEN TO SELECT YOUR DESTINATION

14	General Medicine / Laboratory - Bone Marrow Transplant (BMT)	15	Colonial - Bone Marrow Transplant (BMT)
11	Acute Care for Elders (ACE)	12	Diabetes / Diabetic Control / Respiratory Assessment Unit (DCA)
9	General Surgery - ENT (G)	10	Acute Medical Unit
7	Orthopaedics & Trauma Unit	8	General Surgery / Pediatrics
5	Neurosciences / Tumor (N)	6	Neurosciences
3		4	Urology / Hematology / Skin (U) / Transplant / Plastic Surgery
2	Burn, Trauma & High Acuity Unit / Cardiac Surgery ICU (CSICU) / Intensive Care Unit (ICU) / Food Fair (Sassafraz) / Perioperative Care Centre / Post Anesthesia Care Unit (PACU)		
★1	Admitting / Dialysis / Independent Dialysis Centre / Information Desk / Laboratory Medicine / Rehabilitation Services / Exit to 12th Ave / Café Am / Parkade Skybridge		
G	Daybed / Cardiac Care Unit (CCU) / Heart Services / Nuclear Medicine / X-Ray / CT Scan / Access to Blackmore Pavilion / Access to Emergency / Exit to 10th Ave/Broadway		
B	Tunnel		

SCOTTISH RITE HOSPITAL FOR CHILDREN

10:13 AM | 87 F | Directory | Español

4	Hand Disorders Clubfoot & Foot Disorders
3	Scoliosis & Spine Center Hip Disorders Limb Lengthening
2	Sports Medicine Physiotherapy
L	Concierge Food Services Emergency
B	Receiving Maintenance

WELCOME TO Texas Health Presbyterian Hospital DALLAS

PLEASE PRESS A BUTTON FOR YOUR DESTINATION

5 Front	OB/GYN ORTHOPEDICS & SPORTS MEDICINE	5 Rear	EMERGENCY PREPAREDNESS (Restricted Access)
4 Front	VACANT (Restricted Access)	4 Rear	MAACU PATIENT SERVICES
3 Front	OCCUPATIONAL THERAPY PHYSICAL THERAPY SPEECH THERAPY WOUND CARE	3 Rear	SLEEP LAB (Restricted Access)
2 Front	INFUSION CENTER MENTAL HEALTH & WELLNESS SURGERY	2 Rear	INPATIENT ROOMS (201-224)
G ★ Front	LOBBY CAFETERIA	G Rear	LOBBY

PRESS FOR IMPORTANT INFO

FOOTHILLS HOSPITAL MAIN TOWER

East Service Elevators

TOUCH THE SCREEN TO SELECT YOUR DESTINATION

11	Patient Care Unit 111
10	Patient Care Unit 100 / Unit 101 / Unit 102 / Unit 103A / Unit 103B
9	Patient Care Unit 91 / Unit 92 / Unit 93
8	Patient Care Unit 81 / Unit 82
7	Patient Care Unit 71 / Unit 72
6	Patient Care Unit 61 / Unit 62
5	Labour & Delivery Post Partum / Unit 51 / Unit 52 / NICU
4	Patient Care: Endoscopy Unit 41A / Unit 41B / Unit 42 / Unit 41
3	Patient Care: Rehabilitation Services Unit 31 / Unit 32 / Unit 33 / Link to McCaughey Tower
2	Patient Care Unit 21 / Unit 22 / Unit 23
★M	Main Floor Admitting / Entry / Exit / Link to McCaughey Tower / Link to Special Services Building (SSB)
G	Ground Tribunetone Gardens / Auditorium / Concerts Theatre
B	Basement Link to North Tower

Alberta Health Services

10:48 AM 50°F

UHealth UNIVERSITY OF MIAMI MILLER SCHOOL of MEDICINE

PH	Patient Care: Rehabilitation Services
12	Patient Care: Endoscopy
11	Emergency Preparedness (Restricted Access)
10	Orthopedics & Sports Medicine
9	OB / GYN
8	Patient Services
7	Speech Therapy / Wound Care
6	Occupational Therapy / Physical Therapy
5	Sleep Lab (Restricted Access)
4	Surgery
3	Inpatient Rooms (201-224)
L	Infusion Center / Mental Health & Wellness
★1	Exit / Registration Desk / Cafeteria

TOUCH SCREEN TO SELECT YOUR FLOOR

Passenger Alert Memorial Hospital

CODE BLUE Medical Emergency

Please exit the elevator when the doors open.

Respiratory	Maternity	Cardiac
4	5	6
Admitting	Radiology	Neurology
L	2	3

KEY FEATURES

- The smooth glass surface is easy-to-clean with any glass-approved solution.
- Unlike mechanical pushbuttons, contaminants will not get trapped. A liquid tight bezel prevents accidental entry of fluid into electronics.
- Calls can be placed by finger-touch, or with a gloved/covered hand which helps prevent the transfer of germs.
- Floors requiring special access will appear hidden or faded, and cannot be selected until access is granted from the access card reader.
- When Medical Emergency (such as Code Blue) is activated, graphics automatically change to a simplified layout, including instructions for passengers. Floor numbers will still be present, allowing medical personnel to select the required floor once activated by a key switch or card reader.
- Themes can be customized for specific clientele of the building, such as a Children’s Hospital.
- Directories allows passengers to interactively search for their physician.

Nemours Children's Hospital

Language Selection

Espanol

English

Now you can receive wait time updates on your smartphone!!
Text NCH to 437411

Find your Physician

Press Here

4	Clinical Genetics
3	Dental Services
2	Food & Nutrition
G	Emergency

WELCOME TO SCHNECK

PRESS A NUMBER, DEPARTMENT, OR DOCTOR FOR YOUR DESTINATION
~ YOU ARE FACING THE WEST LOBBIES ~

5 West	OBSTETRICS & GYNECOLOGY / ORTHOPEDICS & SPORTS MEDICINE	FIND YOUR PHYSICIAN PRESS NAME TO SELECT
5 East	EMERGENCY PREPAREDNESS (Restricted Access)	SCHNECK OBSTETRICS & GYNACOLOGY
4 West	VACANT (Restricted Access)	P. Kevin Gerth, M.D. Jill Mikles, D.O.
4 East	INPATIENT ROOMS (412-418)	Kristopher Williams, D.O. Jason Woods, D.P.M.
3 West	OCCUPATIONAL THERAPY / PHYSICAL THERAPY / SPEECH THERAPY / WOUND CARE	Ken Bates, P.A.
3 East	RESPIRATORY THERAPY SLEEP LAB (Restricted Access)	SCHNECK OBSTETRICS & GYNACOLOGY
2 West	SURGERY / INFUSION CENTER / PATIENT SERVICES / IT	Eric Fish, M.D. M. Joel Hallam, D.O.
2 East	INPATIENT ROOMS (201-224)	Adam Jablonski, M.D. Rachel Kozlowski, D.O.
G East	CAFETERIA	Justin Rasner, M.D. Amanda Souza, D.O.
G* West	LOBBY/PARKING	Amy Steffey, M.D. Melanie McGlothlin, N.P.

LANGUAGE SELECTION

ENGLISH

ESPAÑOL

HOTELS

Touchscreens eliminate the need for engraved inserts or plaques on the car operating panels
 Graphics can be changed as needed for special events or promotions.

BERKSHIRE HATHAWAY INC.
Workers Comp Conference 2017
 NOVEMBER 24-25
 Omaha Marriott Regency Circle
 PRESS FOR MORE DETAILS

TOUCH SCREEN TO SELECT YOUR DESTINATION

4 MEETING EVENT SPACE
 3 FITNESS CENTER
 2 POOL
 L* LOBBY

INFINITE POINTS
 EARN UP TO 3,000 POINTS PER STAY!
 PRESS FOR MORE DETAILS

2016 NCAA BASEBALL TOURNAMENT AND COLLEGE WORLD SERIES

Security Error
 33°
 LM 2 3 4 5 6 7 8 9 10 11 12 14 15 16

HYATT REGENCY

14 15 16
 10 11 12
 7 8 9
 4 5 6
 M 2 3
 ★ LOBBY

Swimming Pool
 Health Club
 Mezzanine Level
 2nd Level
 Lobby Level
 Amenity Spa

9:36 AM
 LANGUAGE SELECT
 INSPECTION CERTIFICATE

Eden Roc
 MIAMI BEACH RESORT

19	20	21
16	17	18
12	14	15
9	10	11
6	7	8
3	4	5

LOBBY

LOBBY FITNESS CENTER SPA

CONTINENTAL BREAKFAST FROM 6AM TO 10AM DAILY

THE ORIGINAL
 Iced Latte
 SAVOURY & MELLOW MILK

GAYLORD TEXAN
 10:48 AM
 50°F

TOUCH SCREEN TO SELECT YOUR FLOOR

6	7
4	5
2	3

★ LOBBY

Full Service Spa
 Fitness Center
 Pool
 Meeting Space

10:08 AM
 40°F

15	
12	14
10	11
8	9
6	7
4	5
3	BALLROOM THEATRE / DAWSONS
2	FITNESS CENTER / SPA
L	★ LOBBY / POOL / AMOURATH

HYATT REGENCY
 REGENTON

POOL
 FITNESS CENTER
 SPA
 VINES RESTAURANT
 AMOURATH
 DAWSONS STEAKHOUSE
 BALLROOM THEATRE

TOUCH THE SCREEN TO SELECT YOUR DESTINATION

TRUMP International
 75°F MIAMI
 12:38 PM

FLORIDA'S
 PRESS SCREEN TO SELECT DESTINATION

PENTHOUSE 32		
PENTHOUSE 30		
27	28	29
24	25	26
21	22	23
18	19	20
15	16	17
11	12	14
8	9	10
5	6	7
2	3	4

★ LOBBY ★

NEWS >

SALON
 NEOMI'S
 MEETING ROOM
 LOBBY

KEY BENEFITS

- Seamlessly brand the elevator interior to match your building’s identity through colors and customized themes.
- Highlight building features and amenities such as pool, spa, casino, or restaurants with pictures and video showcasing services (User-defined Area). Schedule and update from anywhere with an Internet connection.
- Inform guests of upcoming special events and promotions.
- Schedule different themes and content depending on the time of day, month or year.
- Interactive informational pop-ups can offer more details to items of interest.
- Wayfinding feature introduces information about the building’s layout and helps guests figure out their path once they exit the elevator.
- Vandal resistant design for high traffic use.

User-defined Area

3:04 PM ENGLISH FRANÇAIS 25°C

Un bon Gin-tonic?
A good gin & tonic?
ALLEGRO GIN-BAR
de 18h à 22h
From 4 pm to 10 pm

23	Les Plaines Resto Le23 (Open weekdays) from noon - 2:00pm Executive Lounge (must be 18 and over)					
17	18	19	20	21	22	
11	12	13	14	15	16	
4	5	6	7	8	9	10
3	Pool	Gym	Sauna			
2	Beaumont Beauport	Bélaïr Bernières	Sales & Administration			
1	Courville Duchesnay Kent Lauzon	Montmorency Orléans Palais Portneuf	Ballroom Sillery Ste-Foy St-Louis			
★	LOBBY De Tourny Dufferin Salon Hilton Villeray Allegro Bar Allegro Restaurant					

GYM
 RESTO Le23
 POOL
 ALLEGRO RESTAURANT

UNIVERSAL Orlando RESORT

Drop by the fitness center tomorrow for a special high-intensity workout

17 **bar17**

14 15 16

8 9 10 11 12

3 4 5 6 7

2 Guest Rooms / Game Room (VR)
Fitness Center / The V-Hub

1 ★ Lobby / Pool / Urban Pantry

75 F 2:35 PM UNIVERSALS Aventura Hotel INSPECTION CERTIFICATE

CORPORATE & COMMERCIAL

Providing tenant names and descriptions makes navigating for visitors easier, while also promoting tenant corporate identity.

12:35 AM 645 MICHIGAN 75 F

1038 Center for Global Health Physical Therapy 1040 Cardiovascular Research 1020 Northwestern University Hematology/Oncology 1006 Developmental Therapeutics Institute 1005 Siron Group, Inc 1000 Eric C. Schaber, M.D.	11 Northwestern University, School of Physical Therapy
822 Karim A. Cohen, M.D. 820 Drs. Lorek, Edgar & Zwick & Pelt 803 Neuropsychological Associates of Chicago	9 R.L. Johnson Physical Alyan Energy USA, Inc Northwestern University, Division of Infectious Diseases
438 IAHF - Coding & Billing Compliance 800 Pass Pass Global	7 Northwestern University, School of Physical Therapy
440 Northwestern Ophthalmology 435 Scottish Development International 423 Alexia A. Ertel, M.D. 422 Howard L. Kirk, M.D. 420 Kansas City Spa 410 Chicago Dizziness and Hearing 400 Allstate Insurance Company	5 Chicago Park Hunt Late Dental Care Access Center Physical Therapy National Council of Structural Engineers Association (NCSA) Northwestern Endocrinology
327 Alphagraphics 320 Strong Productions 300 ReshSystems	3 OREC Architects, LLC

G

PRESS FOR ANNOUNCEMENTS

10:48 AM yonge eglinton centre 21°C

16	17
14	15
12	13
10	11
8	9
6	7
4	5

★ LOBBY

FIT, FRESH & FUN

WINTER | SHAWBOX | TOYS "R" US | ONEFLX VP | CREWAS | SEPTEMBER OPENING JULY 2016

DIRECTORY FLOOR PLAN

RIO CAN

Welcome to Shaw Tower at CATHEDRAL PLACE

23 SYNERGY

22 RAYMOND JAMES®

21 RAYMOND JAMES® - Reception

20 RAYMOND JAMES®

19 OLYMPIA Thomas O'Neill & Associates Robert Samuel Fleming Law Corp. HERMES

18 fm FIRST MAESTIC First Mining Finance Corp.

17 LAWSON LONDELL

16 LAWSON LONDELL - Reception

15 LAWSON LONDELL

14 LAWSON LONDELL - Deliveries

G Lobby

1:34 PM Friday, Feb 19 75°F H: 73° L: 65°

Consumer Technology Association

Producer of CES

NEWS Headlines

TOUCH THE SCREEN TO SELECT YOUR DESTINATION

4	Consumer Technology Association (CTA)
3	Consumer Technology Association (CTA)
2	CTA Cym / Inside Washington Publishers/Patrons
1	Lobby / Micro Market / CTA Conf. Ctr. / The Russell Group / Transcom

G1 Parking / Loading Dock

G2 Parking

G3 Parking

PRESS FOR ANNOUNCEMENTS

70 F 10:48 AM

THE RESTAURANT AND BAR COLLECTION

04 ASCENT	04 R	04 BARMASA
04 perse	04 MASA	04 CENTER BAR
03 BAKERY	03 LAUREL	03 WOOLLY D. BAR
02 SEPHORA	03 WANG BAR	03 BLUEBERRY
C2 EQUINOX	C1 WHOLE FOODS	G Guest Services

2:15 71°F

9	王府 LE GRANDE	MAP
8	商務中心 功能廳 宴會大禮堂 BUSINESS CENTRE FUNCTION ROOMS GRAND BALLROOM	MAP
7	不停此層 NON-STOP FLOOR	MAP
6	蘇湖雅 JARDIN DE SU	MAP
5	風味居 太陽城貴賓會 FENG WEI JU SUN CITY VIP CLUB	MAP
3	娛樂場 娛樂場 娛樂場 CASINO ESUNWANG HORIZON VIP	MAP
2	丹桂軒 LAUREL	MAP
1	娛樂場 珍珠館 大禮堂 名人坊 CASINO PERALS TAI POK THE PALACE	MAP
G	大堂 LOBBY 大堂酒廊 LOBBY LOUNGE	MAP

PHOTO OF HOTEL LOBBY

KEY BENEFITS

- Promote tenant corporate branding.
- Extend design elements from the property to inside the elevator.
- Descriptions provides visitors assurance that they're headed to the correct floor.
- Display advertisements or information on events (User-defined Area). Update and schedule from anywhere with an Internet connection.
- Interactive informational pop-ups can offer more details to items of interest.
- Wayfinding feature introduces information about the building's layout and helps guests figure out their path once they exit the elevator.
- Vandal resistant design for high traffic use.

User-defined Area

333 SEYMOUR

PRESS SCREEN TO SELECT DESTINATION 2:30 PM



SUPPORT YOUR CITY, STAY ACTIVE & JOIN THE FUN BY BIKING TO WORK!

17	P
15 Grant Thornton <small>Licensed Insolvency Trustees</small>	16 Grant Thornton
12	14 RAYMOND JAMES
10	11
8	9
6	7
4	5
3 Government of Canada <small>Gouvernement du Canada</small>	Canadian Grain Commission
2	2R REAR DOOR
MZ	
★ LOBBY	LOBBY REAR DOOR

400 SHERIDAN

10:48 AM | 71°F

5

- 512 Plastic, Reconstruction & Cosmetic Surgery
Dr. Peter Somers M.D.
- 510 Lab Corp
- 508 Miami Beach OB/GYN Associates
Dr. Paul M. Norris
Aissel Faquir ARNP
- 506 Grenada Consulate Miami
- 504 Florida Center, Allergy & Asthma Care
- 502 Dr. Alan S. Kaplin DMD
- 500 Dr. Veronica SanMartino - Dentist

4

- 412 Miami Bch Family & Sports Chiropractic Center
- 410 Dr. Juan Auza
- 406 Dr. Jose Valdivia
Dr. Rachel Build-Libbin
- 404 Dr. Jay Kopk DDS
- 403 Dr. David Vine
- 400 Dr. Lili Estrin

3

- 310 Miami Beach Vain Institute Palm Surgery Center
- 305 Miami Bch Cosmetic Plastic Surgery Center
- 300 South Beach Cosmetic & Dermatology
Dr. Weissman MD
Dr. Merhel MD

2

- 202 Gibraltar Bank
- 201 South Florida Multi-Specialty Associates - Admin
- 200 South Florida Multi-Specialty Associates

L

- 104 Akumin Imaging
- 103 South Florida Multi-Specialty Associates
- 102 Gibraltar Bank

INSTITUTIONS

Live feeds and rotating graphics keeps students informed of upcoming events, campus closures, and other relevant information.

CAROLINA STADIUM MAP

82°F 12:48 PM

- MEZZANINE BOX
- POPE BOX
- 200 LEVEL SEATS
- GROUND LEVEL

UPCOMING GAMES

June 9 4 pm	June 16 3 pm	June 19 Noon	June 20 4 pm

PRESS FOR MORE

Manhattan School of Music

4 5

2 3

1 Auditorium
Street Level

Upcoming Performances Inspection Certificate

10:48 AM 50°F

UHealth UNIVERSITY OF MIAMI HEALTH SYSTEM
MILLER SCHOOL of MEDICINE

PH	Patient Care: Rehabilitation Services
12	Patient Care: Endoscopy
11	Emergency Preparedness (Restricted Access)
10	Orthopedics & Sports Medicine
9	OB / GYN
8	Patient Services
7	Speech Therapy Wound Care
6	Occupational Therapy Physical Therapy
5	Sleep Lab (Restricted Access)
4	Surgery
3	Inpatient Rooms (201-224)
L	Infusion Center Mental Health & Wellness
★ 1	Exit Registration Desk Cafeteria

TOUCH SCREEN TO SELECT YOUR FLOOR

ACADEMY of ART UNIVERSITY

4 5

2 3

Ground

Directory

Campus Events

Sheridan 1:35 PM 25°C

PRESS HERE FOR CAMPUS EVENTS INSPECTION CERTIFICATE

4	Faculty Offices Study Rooms	FLOOR MAP
3	Library Student Centre	FLOOR MAP
2	Library Student Centre	FLOOR MAP
1	Registration Office Cafeteria / Food Court Bus Loop	FLOOR MAP

NETFLIX | JULY 12

Seminoles

6	University Center Club Osceola Grille University Center Club Private Meeting Rooms
5	University Center Club Private Meeting Rooms
4	University Center Club Offices Dedman School of Hospitality Admin Offices Int'l Center for Hospitality Research & Dev.
3	University Center Club Grand Ballroom
2	Hospitality Academic Advising Dedman School of Hospitality Distance Learning Program
1	Seminole Sports Shop FSU Visitor Center

GAME INFORMATION TO GO HERE PRESS FOR MORE

KEY BENEFITS

- Keep students up-to-date on Sports functions.
- Link Twitter and RSS feeds for live campus updates.
- Interactive informational pop-ups can offer more details to items of interest.
- Campus maps helps visitors and new students find their classroom.
- Change screen themes for holidays or campus events.
- Vandal resistant design for high traffic use.
- Active Shooter, Emergency Broadcast, and other security features available.

UNIVERSITY OF NOTRE DAME
Hesburgh Libraries

VIEW BY
FLOOR VIEW BY
CALL NUMBER

14	President's Lounge
13	Philosophy Psychology Religion
12	Theology Subject Librarian Offices
11	Theology History General Europe Russia
10	History Africa the Americas Asia
9	Literatures British American Germanic
8	Political Science Law Education Literatures Classical Celtic Slavic Middle Eastern Asian
7	Medieval Institute
6	University Archives
5	Romance Literatures
4	Technical Services Offices
2	Economics Business Music Art Photography Current Periodicals Classrooms 201c 222 222A 247 248 University Librarian's Suite
1	Center for Digital Scholarship Circulation Computer Cluster Ask Us Help Desk Interlibrary Loan Reference Collection Rare Books & Special Collections Au Bon Pain Café
LL	Geography Anthropology Sports Sociology STEM Collections Military Sciences Bibliography Government Documents Media & Reserves Desk Microforms

Monday, May 24 11:47am library.nd.edu

TEAM NEWS **STADIUM MAP**

82°F 12:48 PM

4 MEZZANINE BOX

3 300 LEVEL SEATS

2 200 LEVEL SEATS

1 GROUND LEVEL

UPCOMING GAMES

Sept 1 4 pm	Sept 8 3 pm	Sept 15 Noon	Sept 21 4 pm
PRESS FOR MORE	PRESS FOR MORE	PRESS FOR MORE	PRESS FOR MORE

AIRPORT

Touchscreen graphics can match icons, colors and typefaces used on building signage for a stress-free and seamless visitor experience.

KEY BENEFITS

- Multiple language selections can be programmed, making the system easy to use for international visitors.
- Interactive maps to help visitors navigate once they exit the elevator.
- Link Twitter and RSS feeds for live airport updates.
- Create ad space for on-site businesses and services (ex. Park N'Fly).
- Familiar icons and large touch-sensitive areas make the system easy to use.
- Vandal resistant design for high traffic use.

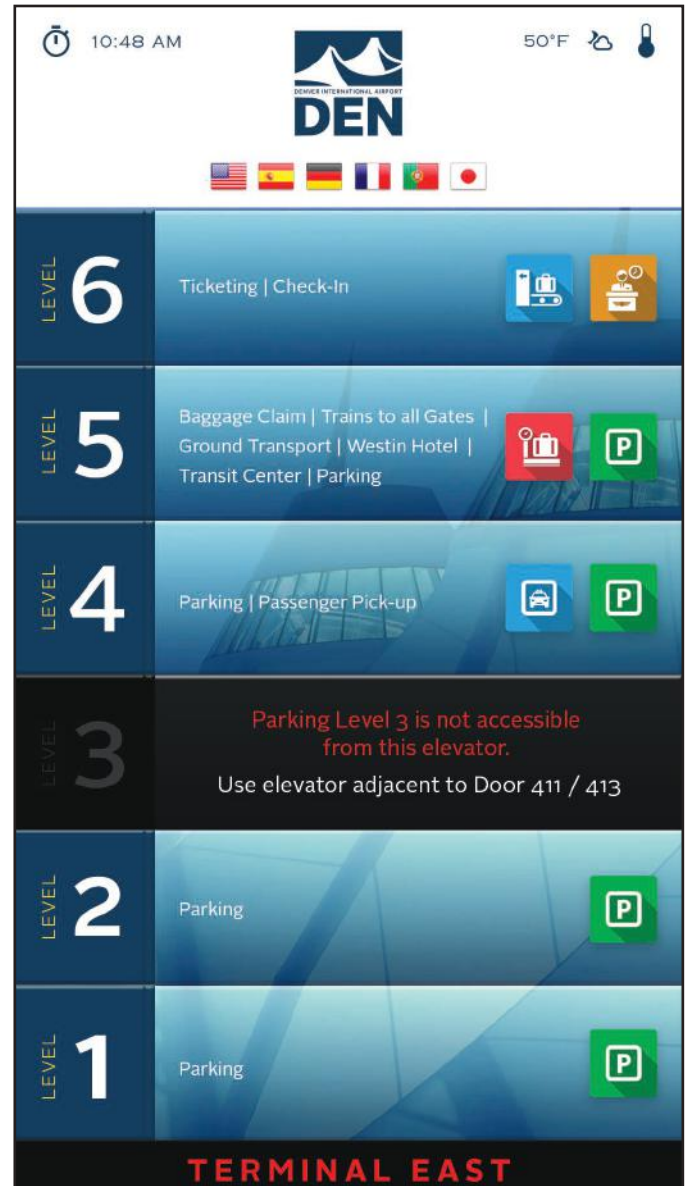
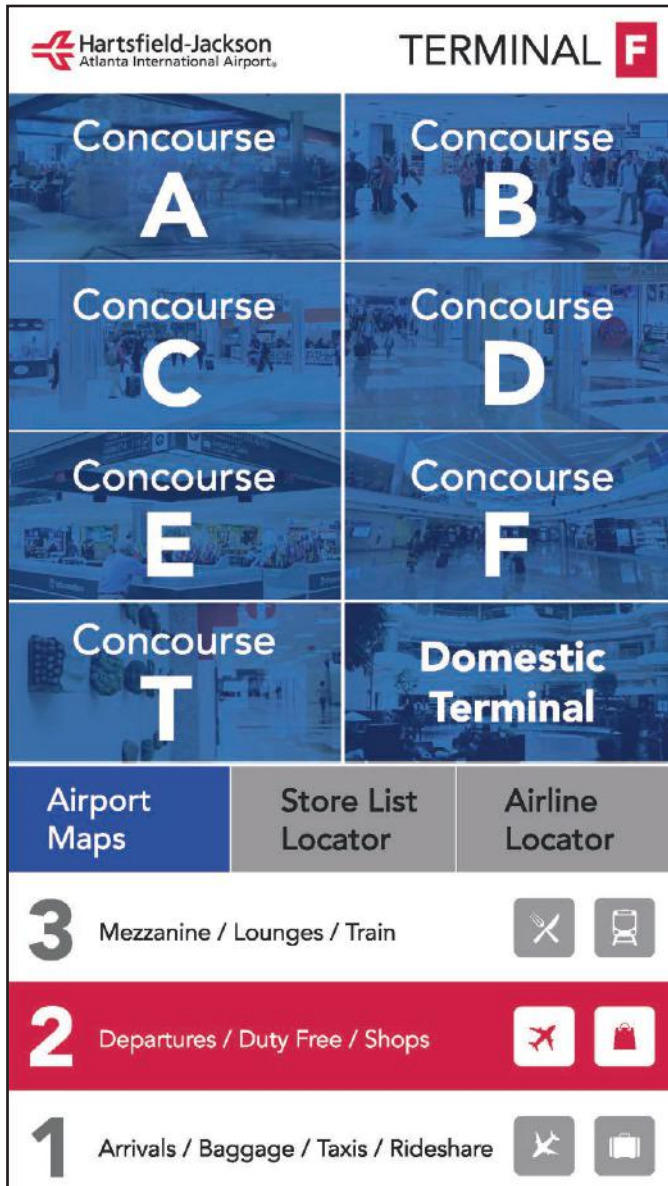

WAYFINDING

The touchscreen graphics can incorporate interactive maps of the facility. Passengers can orient themselves and determine where to go once they exit the elevator.

KEY BENEFITS

- Maps can be unique to each elevator, showing only relevant information.
- Touchscreens can match colors, typefaces and icons used on building signage for a stress-free and seamless visitor experience.
- Anchor store logos and tenant listings can be shown for improved orientation and branding in retail applications.
- Maps can be made interactive to only display upon user request, allowing for other information to be displayed when the map is not required.

7 Administration & Compliance Community Services Environmental Programs Transportation	MAP	8 Community Safety Law Real Estate	MAP
5 Information Technology Help Desk Mail Services	MAP	6 Computer Training Developmental Applications Policy Planning Records Tree Bylaws	MAP
3 Building Approvals Building Inspectors Finance Purchasing	MAP	4 Engineering Production Centre	MAP
M Customer Service First Aid Taxes	MAP	2 Mayor & Council General Managers CAO & CPMG Clerks Communications	MAP
P Parking	MAP	TO DISPLAY FLOOR LAYOUT PRESS THE MAP BUTTON ON RIGHT	

Hartsfield-Jackson Atlanta International Airport **TERMINAL F**

LEVEL 3

4 Boarding Pass Kiosks
Domestic Terminal Train **MAP**

3 Hertz Alamo Enterprise **MAP**

2 Budget ADVANTAGE AVIS **MAP**

1 International Shuttle Connector
Building Management Office **MAP**

FIRE SERVICE

Because the Touch-To-Go touchscreen system only replaces the call buttons, fire operation remains unchanged.

KEY BENEFITS

- Can be operated with a covered or gloved hand.
- Simplified graphics with large touch areas designed specifically for Fire Service mode.
- Touchscreens can be configured to display floor maps of each destination floor once the Fire Service phase I key switch has been activated. This can aid emergency responders in navigating the building.
- Cannot be activated by heat
- In-car monitor such as the Matisse Position Indicator can display a video feed of the destination floor, allowing for assessment of the situation prior to opening the car doors (additional feature).



SWING CARS

In cars that serve high-rise and low-rise floors, the touchscreens offer the ability to limit the floors served by the elevator.

The pushbutton graphics change using a keyswitch in the service cabinet, provides the ability to switch the car between low and high rise operation. In independent service or at activation of phase 1 fire service, graphics change to allow access to all floors served.

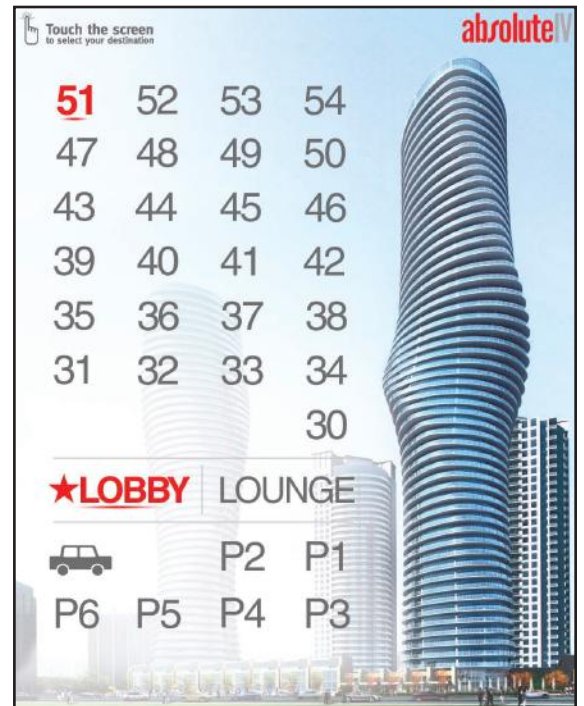

TWO-WAY VIDEO

Our two-way video system allows the passenger to communicate with the Concierge/Security staff in the event of an emergency.

KEY BENEFITS

- Ability to communicate with hearing impaired passengers or those with speech impediments.
- Remotely activate the camera and two-way video communication through a secure connection.
- Advanced attendant service functionality offered as an additional feature, which gives remote elevator control to the Concierge/Security desk. After the visitor is authorized, the Concierge/Security can dispatch the elevator to the desired floor.



DESTINATION DISPATCH

Touch-To-Go touchscreens are a convenient and elegant approach to implementing Destination Dispatch systems in the elevator car.

KEY BENEFITS

- Next floor notification with tenant and branding.
- Interactive maps can help visitors navigate once in full Destination Dispatch mode.
- Digital Signage capability. Update and schedule from anywhere with an Internet connection.
- When control is needed within the car (e.g. Independent Service, Fire Service, or when the elevator is not in Destination Dispatch mode), screens can be activated to accept touch. This eliminates the need for redundant pushbuttons behind locked doors in cabinets.
- Ability to easily and automatically switch between Independent Service, Fire Service, and regular mode provides a smooth implementation and a better passenger experience during upgrades or overlay installation.

User-defined Area

Wayfinding

10:23AM

71 F

UNIVERSITY OF MIAMI HEALTH SYSTEM

Coming Soon to the UHealth App

Wayfinding for:

- UHealth Tower & Parking Garage
- Sylvester Comprehensive Cancer Center
- Bascom Palmer Eye Institute
- Clinical Research Building parking garage

GET IT ON
Google Play

Download on the
App Store

SECOND FLOOR LOBBY

EAST BUILDING

1. Registration
2. Check-in
3. Waiting Area
4. Elevators
5. Urgency Unit/Waiting and/or Elevator
6. Elevators
7. Medical Records
8. Reception
9. Nurse Station
10. Pharmacy
11. Nursing Administration
12. Security

WEST BUILDING

13. Elevators
14. Sylvester Cancer Center

HOURS OF OPERATION

- Starbucks**
 - Monday-Friday: 6 a.m. - 11 p.m.
 - Saturday-Sunday: 7 a.m. - 8 p.m.
 - 305-499-0100
- Walgreens**
 - Monday-Friday: 7 a.m. - 7 p.m.
 - Saturday: 10 a.m. - 2 p.m.
 - Sunday: Closed
 - 305-252-3344
- Security**
 - 24 hours a day, 7 days a week
 - 305-499-5622
- Floor Cleanup**
 - 24 hours a day, 7 days a week
- Credit Union**
 - Monday-Friday: 8 a.m. - 3 p.m.
 - 305-545-5018
- UHealth Celeris First Floor**
 - Cafeteria/Smokeshop: 6:30-12:00 a.m.
 - Breakfast: 7-10 a.m.
 - Lunch: 11 a.m.-2:30 p.m.
 - Dinner: 4:30-6:30 p.m.

←

L3
MAP

L4
MAP

L5
MAP

L6
MAP

L7
MAP

L8
MAP

→

10:23AM

71 F

UNIVERSITY OF MIAMI HEALTH SYSTEM

Visitors who unintentionally board the elevator with no floor selection, *must get off at the next floor and register their floor*

STEP 1

Every rider must select their floor.
Watch for your elevator assignment.

STEP 2

Walk to your assigned elevator
and wait for it to arrive.

STEP 3

Board your assigned elevator.
Inside the elevator, a display indicates your final destination.

Instructions

GRAPHICS

MANAGING CONTENT

MAD Elevator Inc. has an in-house team that provides complete design services. We work directly with the property manager to create custom themes tailored for your building.

If you wish to design themes yourself, files will need to be provided in vector format.

SELF-UPDATING CONTENT

User-defined areas on the screen can be reserved for messages, custom graphics, information, or other custom content. This content can be updated without changing the rest of the graphics.

This space can be used for digital signage: hotels restaurant specials, museum exhibits, construction updates, or any other information a passenger might need to know.

The below examples use their space for announcements.

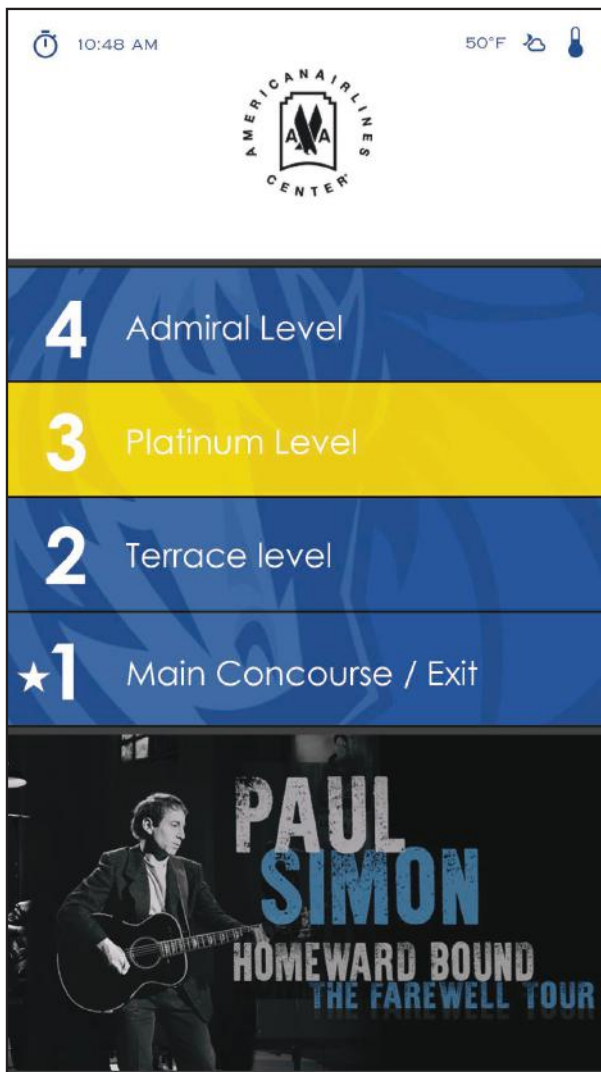

User-defined Area

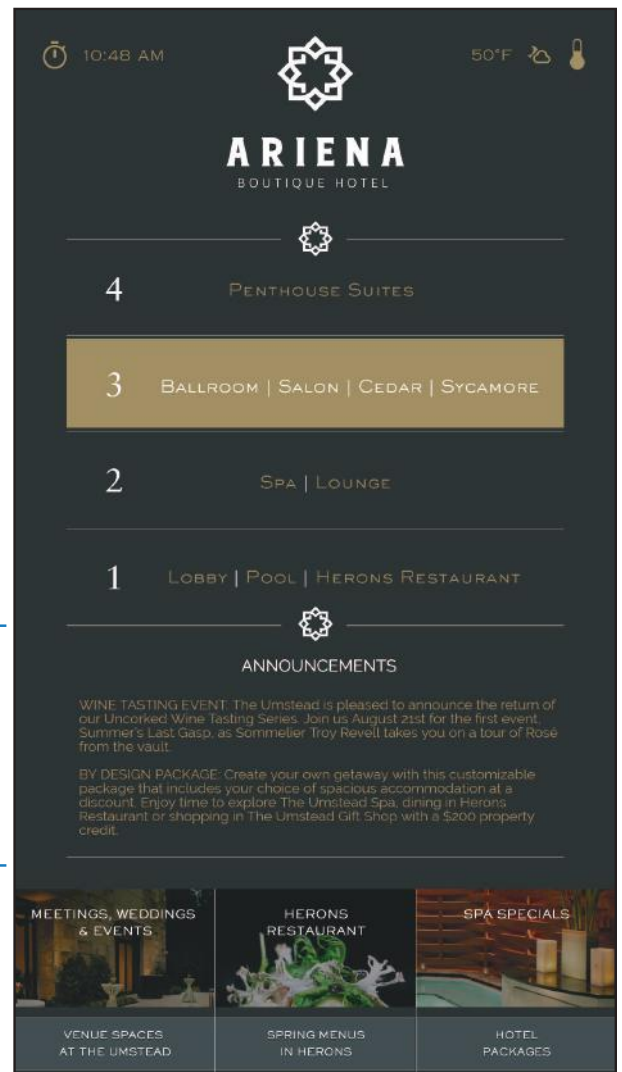

User-defined Area

MosaicONE DIGITAL SIGNAGE SOFTWARE

MosaicONE is a cloud-native program by MAD Elevator Inc. that allows you to generate your own content using text, images, video, news/RSS feeds, time, weather or custom html. Preview, publish, and schedule content to your user-defined area at any time from anywhere with an Internet connection using any web browser. All your screens will be set up for you prior to your first time logging in.

If you also have a Matisse Position Indicator with MAD Elevator Inc., you can access your themes through the same interface.

USER INTERFACE

The screenshot shows the MosaicONE user interface. On the left is a navigation menu with options: BUILDINGS, DEVICES, THEMES (highlighted), USERS, EVENT LOG, and CREDENTIALS. The main area displays the location "123 Main St. East Metropolis" and "ARIENA Boutique Hotel". A "CREATE THEME" button is visible. Below it is a table of themes:

Name	Device Type	PI	Size	Published	Status
Announcement Box	(none provided)		900 x 400	<input checked="" type="checkbox"/>	Idle

Annotations: "Navigation" points to the left sidebar, and "Themes" points to the table.

EDITOR SCREEN

The screenshot shows the MosaicONE editor screen. The top bar includes "Content Options" and "Announcement Box". The main area is divided into "Content Areas" on the left and "Content Properties" on the right. The central content area displays two text blocks:

ANNOUNCEMENTS

WINE-TASTING EVENT: The Umstead is pleased to announce the return of our Uncorked Wine Tasting Series. Join us August 21st for the first event, Summer's Last Gasp, as Sommelier Troy Revell takes you on a tour of Rosé from the vault.

BY DESIGN PACKAGE: Create your own getaway with this customizable package that includes your choice of spacious accommodation at a discount. Enjoy time to explore The Umstead Spa, dining in Herons Restaurant or shopping in The Umstead Gift Shop with a \$200 property credit.

Annotations: "Content Options" points to the top bar, "Content Areas" points to the left sidebar, and "Content Properties" points to the right sidebar.

COMPONENT LAYOUT

KEYPADS

The keypad is a secondary method by which passengers can select their destination floor. It is intended for use by persons who are unable to use the touchscreen system (e.g. due to visual impairment or other disabilities).

The keypad complies with the 2010 ADA Standards for Accessible Design and ASME A17.1-2007 / CSA B44-07 Appendix E requirements for persons with physical disabilities. The keypad is also compliant with earlier codes CSA B44-00 and CSA B44-04. A special keypad is available meeting California requirements.

The keypad is approximately 4.25" x 5.75" in size, and markings for the non-numeric keys can be customized to meet the needs of each elevator.

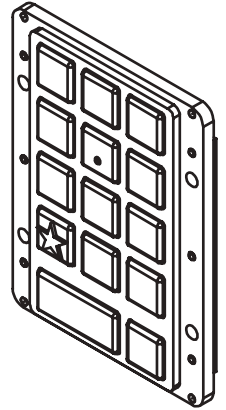

SERVICE PORT

The system's service port is located in the elevator's service cabinet. Along with two keyed switches, the service port allows for administration of the system without the need to open the car operating panels.

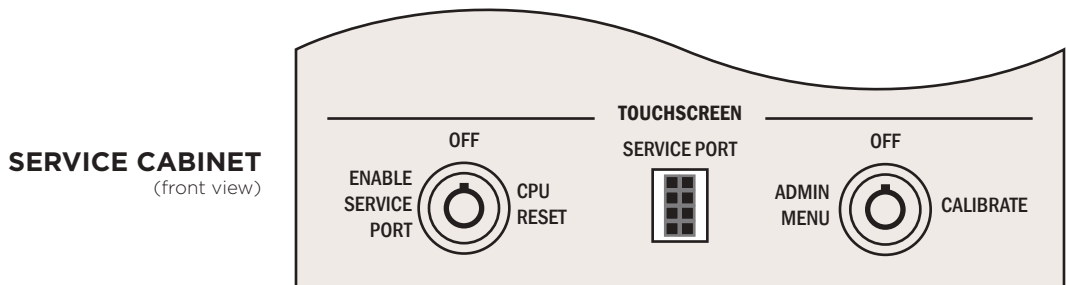

Three-position keyed switch
Two independent sets of N.O. contacts
Key removable in OFF position only
Key trapped in other positions
Spring-loaded in CPU RESET position only

Three-position keyed switch
Two independent sets of N.O. contacts
Key removable in OFF position only
Key trapped in other positions
Spring-loaded in ADMIN MENU position
Spring-loaded in CALIBRATE position

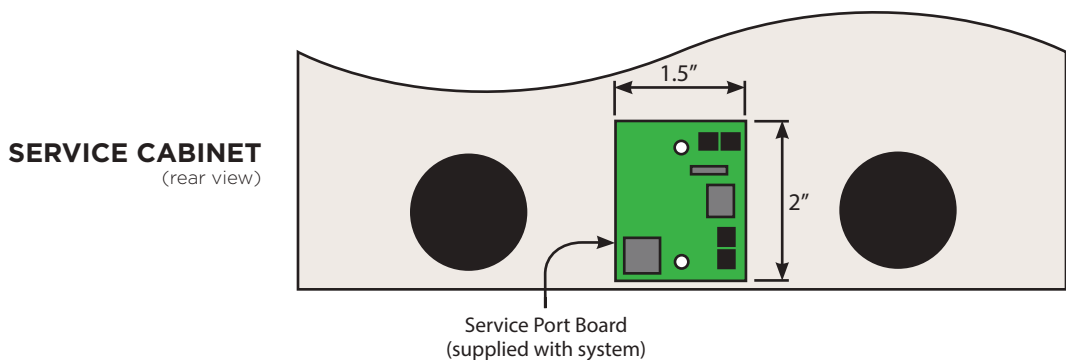

ELEVATOR INTERFACE UNIT

The elevator interface unit is the device responsible for handling all communications between the elevator and the touchscreen system. It is mounted to the rear of the keypad.

It is fully electrically isolated from the elevator wiring. Destination floor requests are sent to the elevator via contact closures, and acknowledgements are received via illumination of LEDs, similar to conventional buttons. **In almost all cases, wiring is identical to what would be done for conventional buttons.**

The elevator button wiring connects to the elevator interface unit; all wiring for destination floor pushbuttons must be routed here. Cables from the elevator interface unit also connect to the service port in the service cabinet, and to the CPU panel. Sufficient clearance must be left around this device to allow for these connections.

Elevator interface units are available in multiples of 24 floors, supporting elevators with up to 24, 48, 72, or 96 stops. A CAN-bus unit is also available, greatly reducing field wiring requirements.

STANDARD 3-WIRE CONNECTION

LED common, button common, and 1 wire per floor

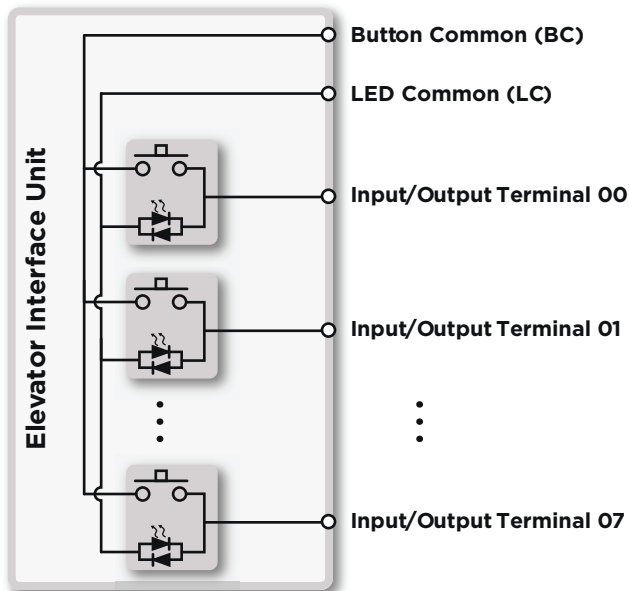

OPTIONAL 4-WIRE CONNECTION

LED common, button common, and 2 wires per floor

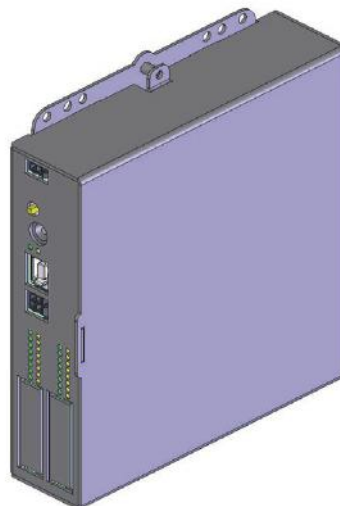
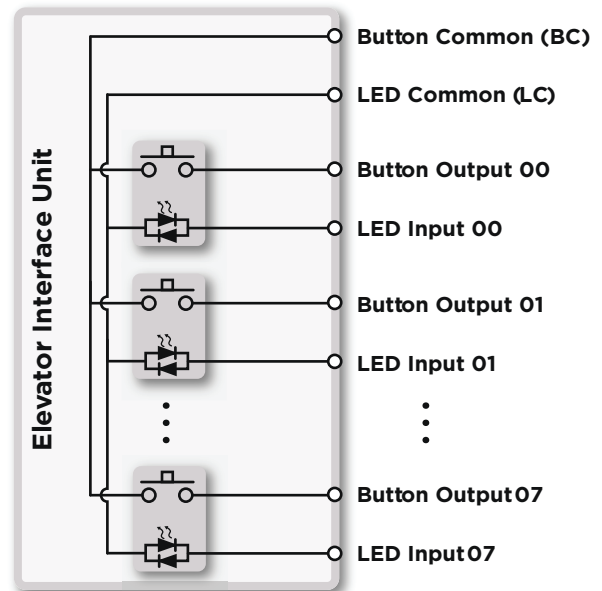

21W TOUCHSCREEN WITH INTEGRATED CPU

Our 21.5" touchscreen contains a robust and powerful integrated CPU, built directly into the touchscreen housing. For maximum reliability, the device is passively cooled and constructed from solid-state components with no moving parts or fans.

This integrated design greatly reduces space and wiring requirements within the COP, in addition to simplifying service and installation processes.

All wiring connections to other components terminate on the back of the touchscreen. Polarized connectors are used to prevent connection errors, and the use of locking connectors and cable clamps prevents cables from being accidentally dislodged.

The touchscreen is only 47.5mm (1 7/8") thick, making it easy to fit in most COPs.

A full-HD industrial-grade LCD panel is used, with a long-lifespan LED backlight and very wide viewing angles. This produces a crisp, bright, vivid image.

The 21W touchscreen is powered by a small 12VDC power supply separately mounted in the COP.

IMPORTANT: Passively cooled; keep away from other heat-generating equipment
Leave clearance above and below for natural convection airflow

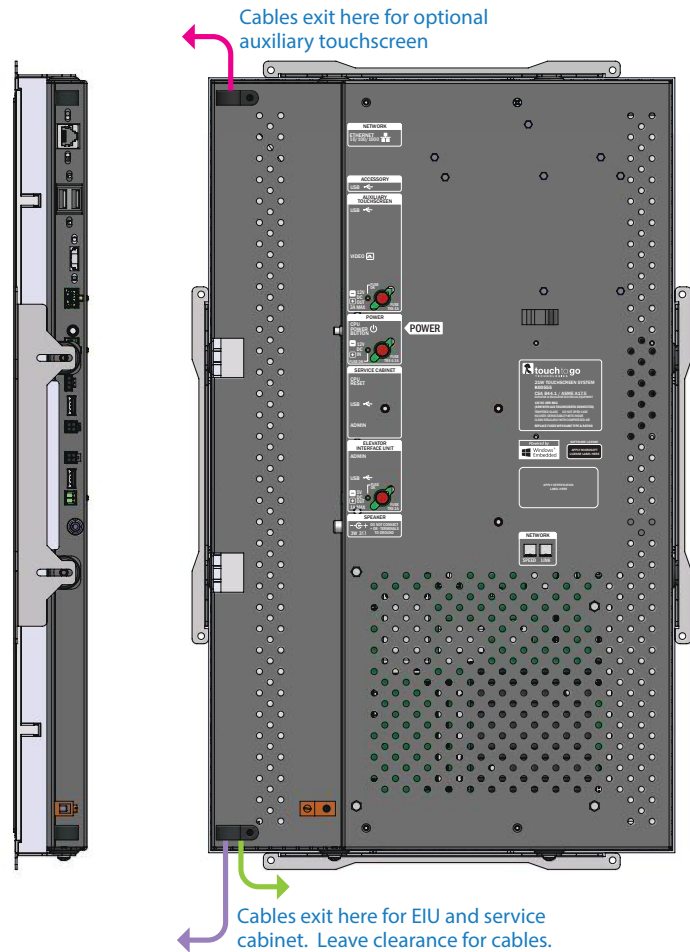

OTHER TOUCHSCREENS - SPECIAL ORDER ONLY

The 21W touchscreen contains an internal CPU. Other sizes (available by special order) require a separate CPU panel which controls the operation of the touchscreens. It must be installed inside the car operating panel. Only one CPU panel is required per elevator, even if there are two touchscreens present. This CPU panel is 11.75" x 8.5" x 3.3". Please inquire for further details.

For maximum reliability, the CPU panel is constructed from solid-state components with no moving parts or fans.

AC power is connected to the system at the CPU panel. For dual car-operating panel elevators, mount the CPU panel in the lower portion of the COP. Cables to the other COP are routed out the bottom of the CPU panel and beneath the elevator doors.

POWER AND WIRING REQUIREMENTS

The system requires an AC power connection of 100-120V AC 3.5A MAX, 50-60Hz or 200-240V AC 2A MAX, 50-60Hz and is to be connected to a maximum 20A branch circuit. Conductors shall be Cu, Al, or Cu-Al, and the ground wire must be 14AWG. Typical power consumption is 40-60W.

The AC power must come from a reliable uninterrupted source of power to keep the system operational. This connection is made at the CPU panel. All components outside of the CPU panel operate from low voltage DC power supplied by the CPU panel.

Electrical codes generally require a dedicated circuit for car lighting; therefore it is advised that the touchscreen system be supplied by an alternate circuit. The circuit powering the touchscreen system must shut off when the main power to the elevator control is shut off.

EMERGENCY CONTROLS AND DOOR OPEN/CLOSE

Emergency controls, door open, door close, etc. should be implemented with conventional pushbuttons; the touchscreen only supports selection of the destination floor.

NETWORKING (optional)

Multiple elevators can be networked together to simplify processes such as system configuration or graphics updates.

If systems are to be networked, a one sided twisted-pair must be included in the traveling cable. Devices to extend interior from controller to elevator car are used, and connections to devices are made with CAT5 cables. An internet access point is provided in the machine room and ranked to each controller.

POWER SAVING MODE (optional)

Touch-To-Go Elevator Touchscreen Systems include a power-saving mode which can turn off the touchscreens after a configurable period of inactivity. This prolongs the life of the LCD.

INSTALLATION

Installation of a Touch-To-Go touchscreen system is straightforward. Car operating panels can be supplied with the equipment installed, prewired, and tested. This reduces on-site labour and makes the process as simple as possible.

For customers who wish to install the system in their own COPs, a detailed installation manual is provided with each order. The process is simple and steps can be summarized as follows:

- Mount the touchscreen to the cutout and studs in the COP
- Mount the keypad to the cutout and studs in the COP
- Mount the elevator interface unit to the rear of the keypad
- Mount the CPU panel to the studs in the COP
- Mount the service port board to the studs in the service cabinet
- Connect the keyed switches to the service port board
- Connect the cables (supplied) from the CPU panel to each of the other components
- Connect the elevator button wiring to the elevator interface unit
- Connect power to the CPU panel

Systems are shipped preloaded with graphics for each job, and preprogrammed with the required operating parameters. They are ready to use upon power-up, and in most cases, no on-site programming or configuration is needed.

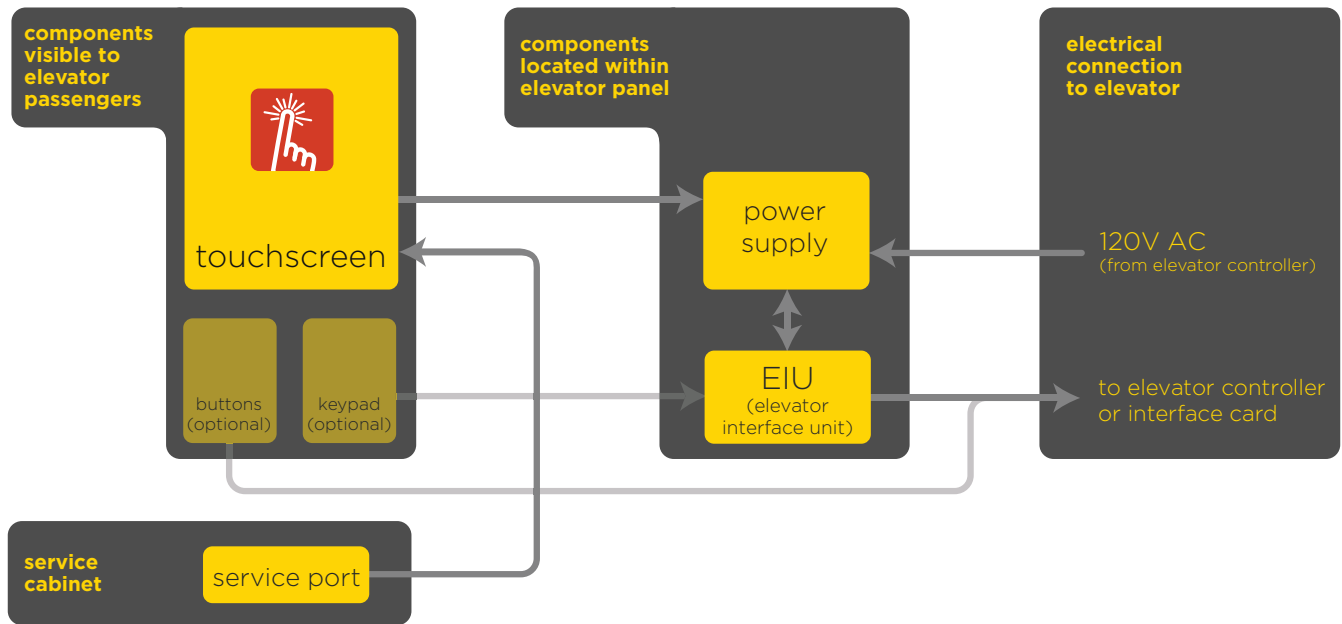

Block Diagram - Equipment Connections

i The information in this document has been provided to assist with designing a code-compliant car operating panel. In this document, the term 'code-compliant' is intended to specifically refer to codes addressing use by persons with disabilities; it does not refer to more general elevator or safety codes, compliance with which must be verified separately. The document may contain unintentional errors or omissions, and codes and standards may have changed since the document was prepared. Touch-To-Go Technologies does not guarantee that the information in this document is applicable to all jurisdictions; you are responsible for verifying all details pertaining to your installation.

CODE COMPLIANCE

When installing an elevator touchscreen system, it is important to consider use of the system by disabled passengers and ensure that the elevator car meets all necessary codes pertaining to accessibility.

An elevator touchscreen system can provide greater accessibility to visually impaired passengers. Through the use of larger, high contrast virtual buttons, information is more readily available. The touchscreen requires only 55 grams of force to operate, which is less than a traditional pushbutton.

However, there may be cases where a passenger is unable to operate the touchscreen, and in these cases it is important to comply with applicable codes and standards. Two options are available for achieving compliance with codes specific to use by the disabled: the touchscreen may be coupled with a keypad, or with a set of conventional buttons.

KEYPAD - SPEECH OUTPUT

The disability access requirements of the City and County of San Francisco Department of Building Inspection require keypad console speech output. This section details the speech-related features available on the Touch-To-Go product.

Note that speech output requires a dedicated loudspeaker (3Ω, 3W) to be provided as part of the car operating panel; this can be supplied by Touch-To-Go, or a customer-supplied speaker can be used if available.

Speech output is offered as an option for California keypads as well as for standard keypads.

Item	City and County of San Francisco Department of Building Inspection, Administrative Bulletin #AB-090	Touch-To-Go System
Verbal announcement of floors served	When the Accessibility Function key is pressed, a verbal announcement of floors served by the elevator group shall be provided.	When the Accessibility Function key is pressed, the system can speak a user-configurable phrase that can describe the floors served.
Instructions	After the Accessibility Function key is pressed, a speech prompt shall direct the user to enter a destination floor.	When the Accessibility Function key is pressed, the system can speak a user-configurable phrase that instructs the user to enter their destination floor. Note that this phrase is independent of and in addition to the announcement of floors served.
Announcement of keypad entry	When a destination floor has been entered on the keypad or through an access control system, a speech prompt will, within two seconds, indicate the destination floor that was entered.	When a destination floor has been entered on the keypad, a speech prompt will indicate the destination floor that was entered. This happens within two seconds of the entry being accepted.
Invalid entries	The keypad console shall make an audible indication of an invalid key press sequence.	The keypad will make a beep tone if the key sequence is not valid.
Speech volume	Auditory volume shall be at least 10dBA above ambient sound level, but not more than 80 dBA.	Volume is to be set by the installer of the equipment.
Relevant section of the bulletin	Section I, part E (Keypad Console Speech Output)	

STANDARD KEYPAD

The following drawings and table are provided to help confirm the standards compliance of the keypad.

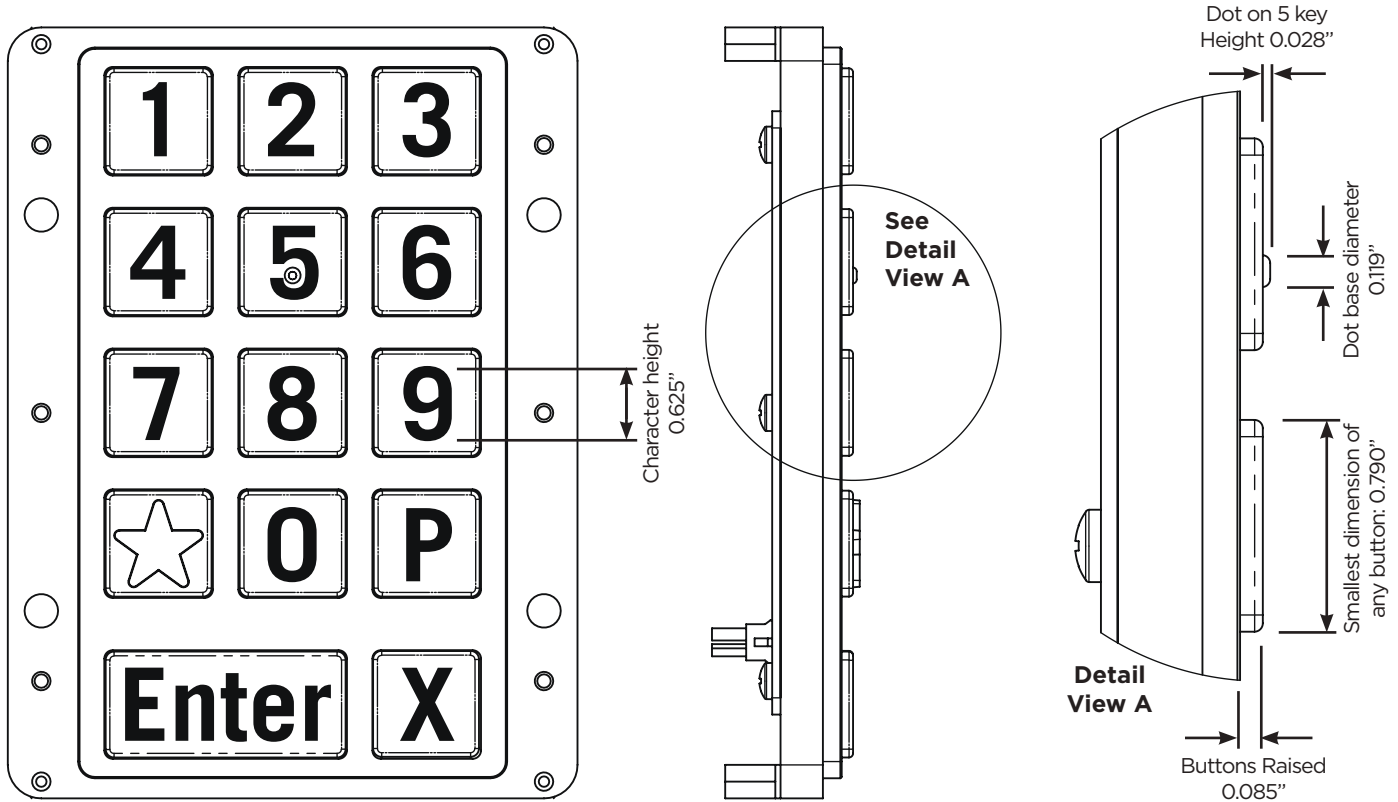

Item	Touch-To-Go Keypad	ASME A17.1-2007 CSA B44-07 Appendix E	ANSI A117.1 1998	2010 ADA Standards for Accessible Design
Numerical key arrangement	Standard telephone sequence	Standard telephone sequence	Standard telephone sequence	Standard telephone sequence
Button Size	0.790"	Minimum 0.750"	Minimum 0.750"	No requirement defined
Button Height	0.085"	Minimum 0.060"	Raised or flush	No requirement defined
Operating Force	Finger-activated; less than 1 pound force to operate.	No requirement defined	No requirement defined	Operable by one hand, no grasping, pinching, or twisting. Max 5 pounds force to operate.
Character Height	0.500" (Canada only) 0.625" (Canada or USA)	Minimum 0.500"	No requirement defined (elevators excluded from character height requirements)	Minimum 0.625"
Character Placement	Centered	Centered	Centered	Centered
Character Font	High contrast, non-glare Conventional character forms Black on matte silver	High contrast, non-glare Conventional character forms	High contrast, non-glare Conventional character forms	High contrast, non-glare Conventional character forms
Dot on '5' key	Base diameter 0.119" Height 0.028"	Base diameter 0.118 -0.120" Height 0.024-0.031"	Base diameter 0.118 -0.120" Height 0.025-0.037"	Base diameter 0.118 -0.120" Height 0.025 to 0.037"
Main entry floor	Five-pointed star to indicate main entry floor	Five-pointed star to indicate main entry floor	Five-pointed star to indicate main entry floor	No requirement defined
Visual display	Touchscreens will show registered car destinations	Visible indicators must show registered car destinations	Visible indicators must show registered car destinations	Visible indicators must show registered car destinations
Relevant sections of each standard		E-9.5 (car control keypads) E-20.4 (characters)	407.2.11.1 (car control buttons) 407.2.11.2 (keypads) 703.4 (characters)	407.4.6.3 (key arrangement) 407.4.7.2 (keypads) 703.5 (characters) 309.4 (operating force)

CALIFORNIA KEYPAD

A special keypad design is available to address the disability access requirements of the City and County of San Francisco Department of Building Inspection. The following drawings and table are provided to help confirm the standards compliance of this keypad. Because this keypad also complies with the standards mentioned on the previous page, those will not be repeated here.

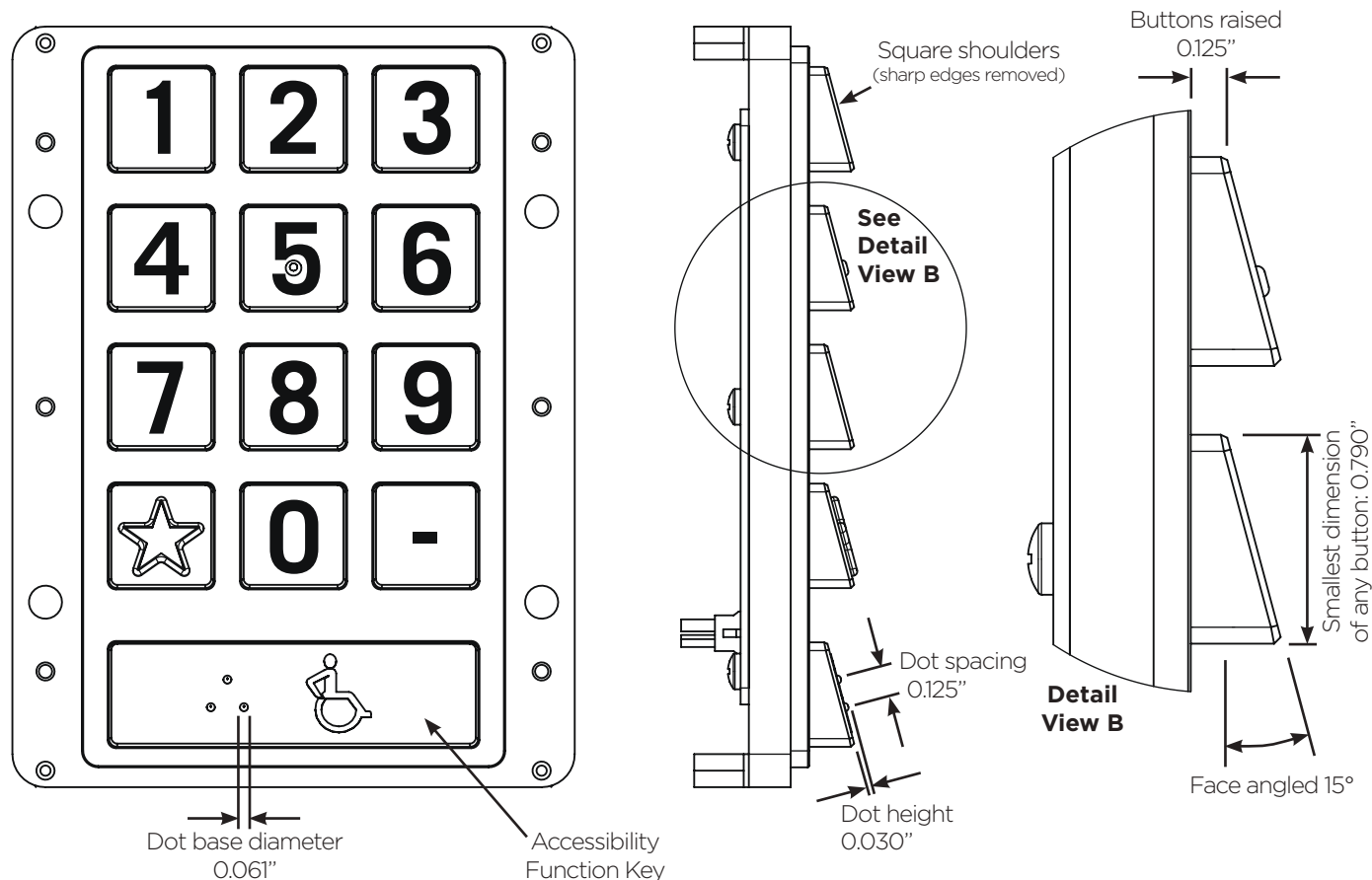

Item	City and County of San Francisco Department of Building Inspection, Administrative Bulletin #AB-090	Touch-To-Go Keypad
Numerical key arrangement	Standard telephone sequence, 12 keys	Standard telephone sequence, 12 keys
Button Size	0.750" minimum	0.790"
Button Height	0.125" minimum	0.125"
Button Shape	Square shoulders, no sharp corners or edges	Square shoulders on face, sharp edges removed
Button Slope	15° to 25°	15°
Character Font	White characters on a black surface	White characters on a black surface
Minus key	Minus sign on key in lower right corner	Minus sign on key in lower right corner
Star key	Five-pointed star key in lower left corner dispatches elevator to main entry floor	Five-pointed star key in lower left corner dispatches elevator to main entry floor
Accessibility function key	Below numeric keys, rectangular or square in shape, larger than other keys, contains ISA and raised triangle symbol	Below numeric keys, rectangular, larger than other keys, contains ISA and triangle symbol
Button action	Mechanical, detectable motion	Mechanical, moves when pressed
Additional keys	If present, additional keys must be to the right of the numeric keypad, with raised lettering and braille.	No additional keys
Relevant section of the bulletin	Section I, part C (keypad)	

ACHIEVING COMPLIANCE USING CONVENTIONAL BUTTONS

For buildings whose elevators serve a small number of floors, one to two rows of compact conventional pushbuttons may be located beneath the touchscreen. For elevators with dual car operating panels, this set of buttons is typically only required on one of the two panels in order to achieve compliance with disability and accessibility codes.

For the purposes of evaluating code compliance, the buttons can be considered to be the primary means of operating the elevator, and the touchscreen can be considered as being supplemental to the buttons. As long as the buttons are installed in a manner that complies with disability and accessibility codes, no further changes are needed as a result of the presence of the touchscreen.

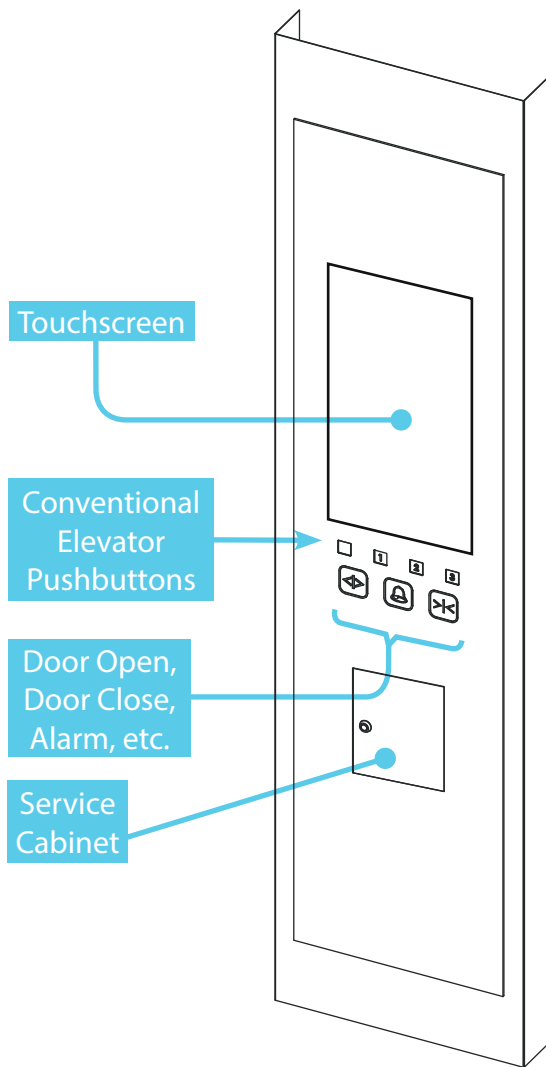

ACHIEVING COMPLIANCE USING A KEYPAD

For buildings whose elevators serve a moderate to large number of floors, a tactile keypad is available for entering a destination floor.

The keypad is compliant with the requirements of ANSI A117.1 and ASME A17.1 / CSA B44 Appendix E-9.5 and the 2010 ADA Standards for Accessible Design. It contains a dedicated ground floor button and automatically rejects invalid call requests. The keypad is a space-efficient solution for achieving code compliance in buildings with a large number of floors. For elevators with dual car operating panels, only one keypad is required or supported per elevator.

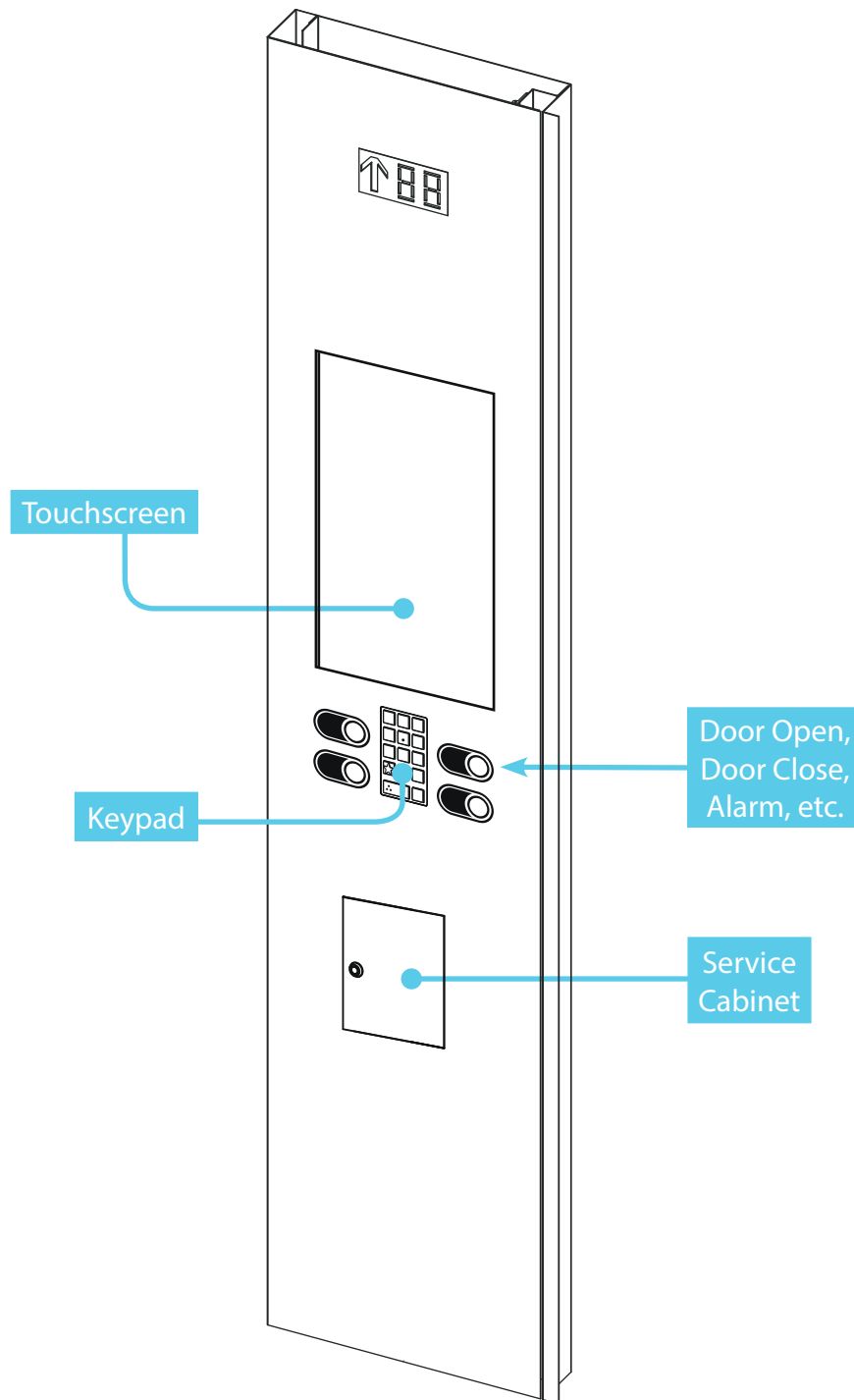

SPECIFICATIONS

ITEM	SPECIFICATION
Operating Temperature Range	Touchscreen and CPU: 0°C to 50°C (operating), -20°C to 60°C (storage) Keypad and Elevator Interface Unit: -20°C to 60°C
Standards Conformance, System	Elevator and Escalator Electrical Equipment Conforms to ASME A17.5-2011 Certified to CSA B44.1-11, Fourth Edition Intertek/ETL-listed as a Recognized Component (C/US)
Standards Conformance, Keypad	CSA B44-07 Appendix E (and older editions -00 and -04) ASME A17.1-2007 Appendix E (and older editions 2000 and 2004) ANSI A117.1-2003 and 1998 (and proposed 2008 standard) ADA Standards for Accessible Design, 2010 edition
Fail-Safe Operation	In a system with two touchscreens, in the event of failure of one touchscreen, the other touchscreen remains operational. In a system with keypads, in the event of a failure of the touchscreen(s) or CPU, the keypad remains operational. Power is required for the keypad to operate and it is recommended that the system be supplied by an uninterrupted source of emergency power. In systems with conventional elevator buttons, in the event of a failure of the touchscreen(s) or CPU, the elevator may still be operated by conventional elevator buttons.
Emergency Recall / Fire Service	The Touch-To-Go elevator touchscreen system does not affect the ability of the elevator to respond to emergency recall or fire service requests.
Fire Retardation	The touchscreen meets UL standard 94HB.
Vandalism / Breakage Resistance	Touchscreens are constructed from tempered glass with a safe break pattern. They contain no overlays or coatings to wear out, scratch, or tear. The touchscreen meets the UL-60950 and CSA 22.2 No. 60950 ball drop test requirements (0.5 kg, 50 mm diameter ball dropped from 1.3 m).
Electrostatic Protection	The touchscreen meets Level 4 (15 kV air/8 kV contact discharges) per EN 61 000-4-2, 1995.
Chemical resistance	The active area of the touchscreen is resistant to all chemicals that do not affect glass, such as acetone, toluene, methyl ethyl ketone, isopropyl alcohol, methyl alcohol, ethyl acetate, ammonia-based glass cleaners, gasoline, kerosene, and vinegar.

i This document may contain unintentional errors or omissions, and codes, standards, or product specifications may have changed since this document was prepared. Touch-To-Go Technologies does not guarantee that the information in this document is applicable to all jurisdictions; you are responsible for verifying all details pertaining to your installation.

APPROVALS

The following letter was received by MAD Elevator Inc. following a presentation of the Touch-To-Go Elevator Touchscreen System to the New York City Department of Buildings Elevator Unit. The system was approved by New York City and found to be in compliance with all applicable codes. Please verify compliance with local codes in your area; we are happy to assist with any questions you may have.

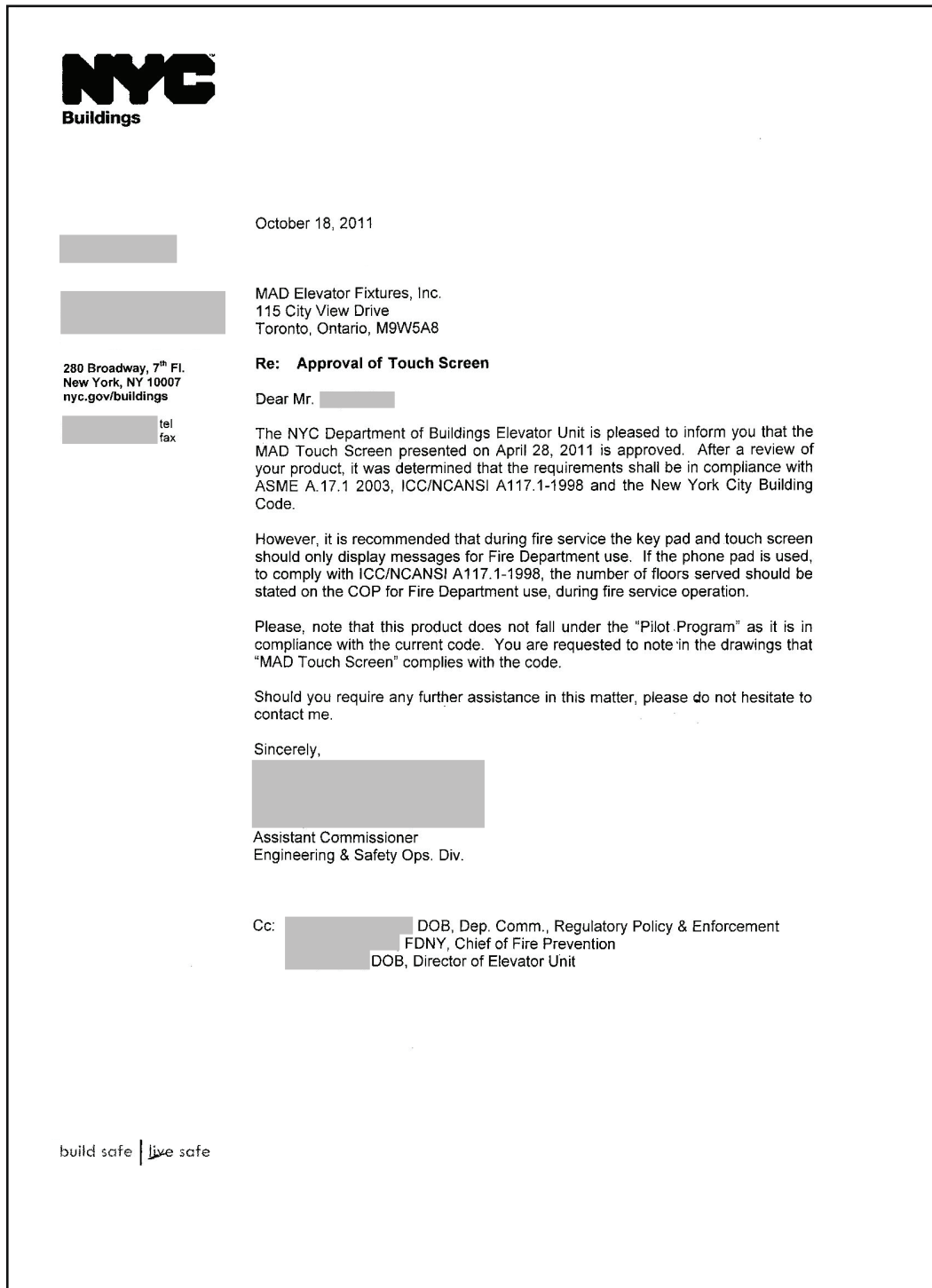







1806 S. Lake Stevens Rd
Lake Stevens,
WA 98258
360-862-8328
info@liftsolutions.net
www.liftsolutions.net

© MAD Elevator Inc.